



1. Intended use:

The RACK 19" cabinet enables integrating CCTV, AC, I&HAS, RTV, LAN, or other systems in medium and big companies. It is intended for devices manufactured in enclosures of the 19" standard. Due to the RACK cabinets, the devices are aesthetically mounted and protected against mechanical damage.

2. Specifications:

SPECIFICATIONS	
Mounting dimensions:	W=19", H=42U, D=760mm
External dimensions:	W=600, H=2055, D=1000 [mm, +/-2]
Net/gross weight:	111 / 117 [kg]
Materials:	<ul style="list-style-type: none"> - RACK mounting rails: cold-rolled steel SPCC 2mm - bolted - horizontal mounting rails: cold-rolled steel SPCC 1,5mm - bolted - frame: cold-rolled steel SPCC 1,2mm RAL 9004 - welded - front door: 5mm toughened glass / SPCC 1,2mm RAL 9004 - hinged - side panel: cold-rolled steel SPCC 1,2mm RAL 9004 - removable - rear door: cold-rolled steel SPCC 1,2mm RAL 9004 - hinged
Static load:	1000 kg (with leveling feet)
Use:	inside, IP20
Notes:	<ul style="list-style-type: none"> - adjustable distance between front and rear RACK rails - ventilation holes in the front door, top and bottom panel - possible mounting of a fan unit in the top panels - RAWP (max. 2 pcs.) - cable ducts in the top and bottom panel - 4 casters without locks and 4 leveling feet included - possible assembly of a 100mm high plinth - RAC166M - lockable front door (2 keys in set) - lockable rear door (2 keys in set) - side panel - lock assembly possible - RAZB16 - ready-to-assemble
Declarations, warranty:	RoHS, 12 months from the date of purchase

3. Structure of the RACK cabinet.

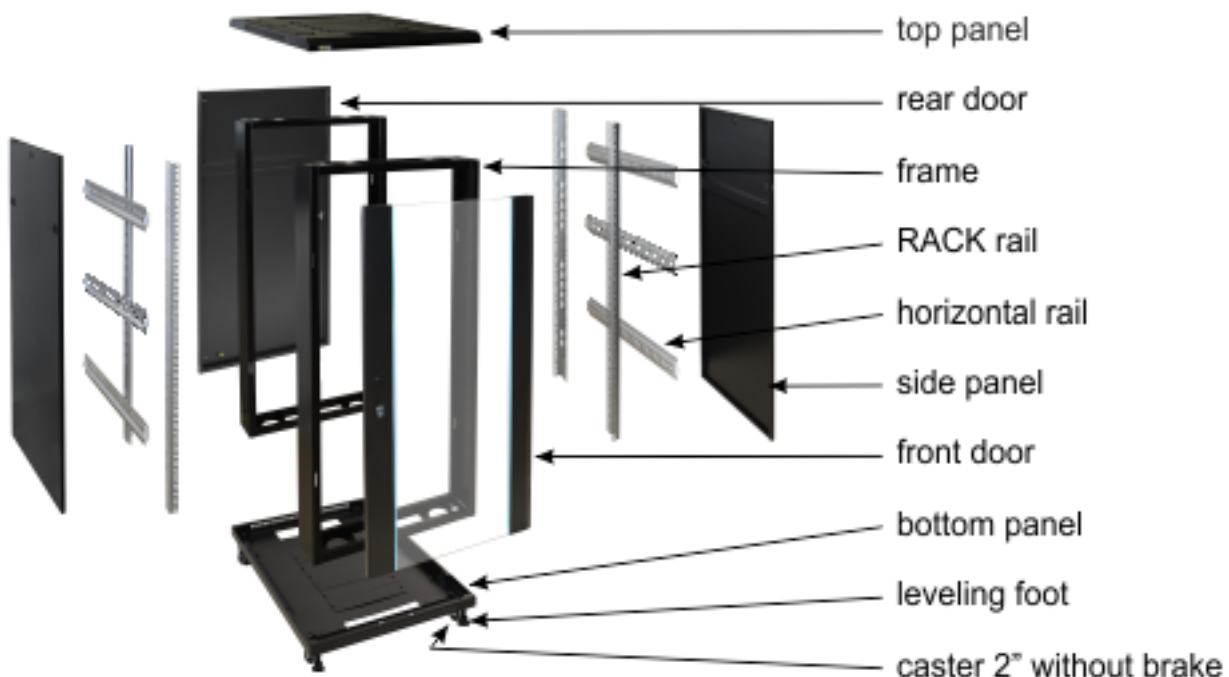

4. Components

Number	Component	Amount	Foto	Number	Component	Amount	Foto
1	Top panel	1 pcs.		11	"2" wheel without lock"	4 pcs.	
2	Bottom panel	1 pcs.		12	Leveling foot	4 pcs.	
3	Front doors	1 pcs.		13	M8x12 Head Cap Screw	16 pcs.	
4	Rear door	1 pcs.		14	M8 nut	16 pcs.	
5	Side panel	2 pcs.		15	10mm Torx (black)	97 pcs.	
6	Cabinet frame	2 pcs.		16	M5 nut, spring washer	2 pcs.	
7	Horizontal rail	4 pcs.		17	Spacer for front/rear doors	2 pcs.	
8	RACK 19" 42U rail	4 pcs.		18	M6x12 Phillips screw	20 pcs.	
9	Cable gland end cup (upper)	2 pcs.		19	M6 nut („cage nut")	20 pcs.	
10	Cable gland end cup (lower)	2 pcs.		20	Torx /hex key	1 pcs.	

5. Assembling instructions of RACK:

The free standing, ready-to-assemble RACK cabinet is delivered in 4 separate packages.

5.1) Place horizontally two RACK cabinet frames with both top and bottom plates. Pay attention to the grounding in the frame - as shown in the drawing



5.2) Mount the top plate and bottom plate to the left and right frames of the RACK cabinet, respectively. Use M8X12 Head Cap Screws with M8 nuts (16pcs). Screw the cabinet **wheels** and **legs** to the bottom plate of the cabinet.



5.3) Place the RACK cabinet vertically and mount:
- Cable gland end cups (up and down) –screw 10mm (black) - 12pcs

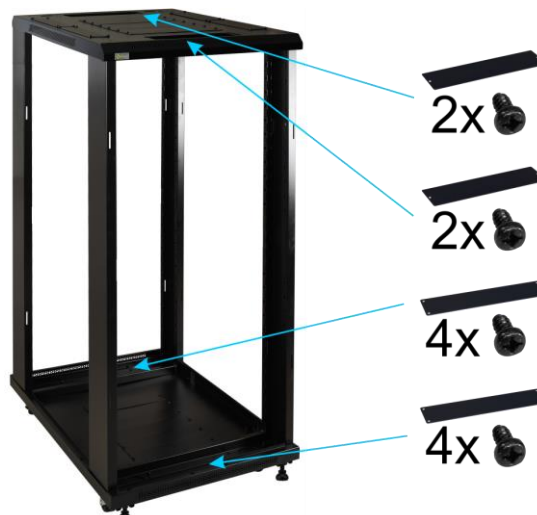

5.4) Inside the cabinet, install the cross profiles and RACK profiles from the inside (front and rear), as shown in the figure below.



5.5) Installation of front, rear, and side doors



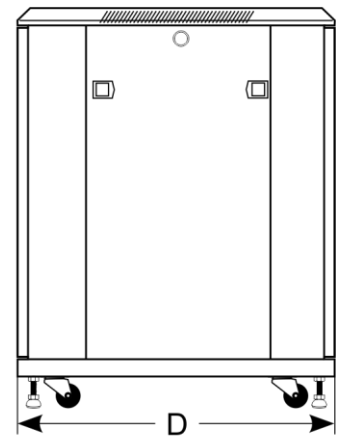
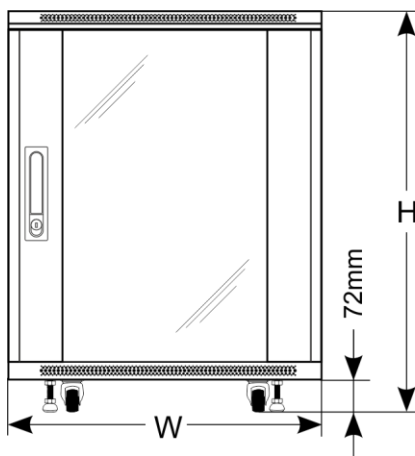
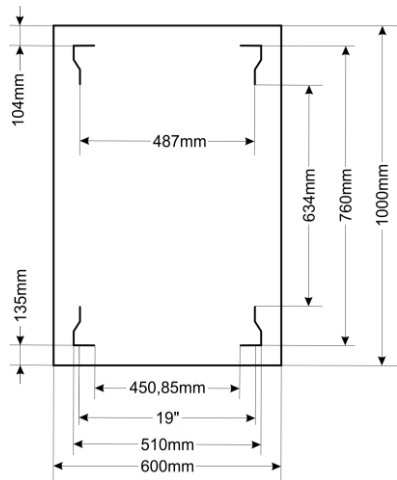

MANUFACTURER

Pulsar sp. j.

Siedlec 150,
32-744 Łapczyca

Tel. 14-610-19-40, Fax. 14-610-19-50

e-mail: biuro@pulsar.pl, sales@pulsar.pl

http:// www.pulsar.pl, www.zasilacze.pl